

Analog Devices Welcomes Hittite Microwave Corporation

NO CONTENT ON THE ATTACHED DOCUMENT HAS CHANGED



THIS PAGE INTENTIONALLY LEFT BLANK



GaAs pHEMT MMIC 2 WATT POWER AMPLIFIER, 0.1 - 22 GHz

Typical Applications

The HMC998 is ideal for:

- Test Instrumentation
- Microwave Radio & VSAT
- Military & Space
- Telecom Infrastructure
- Fiber Optics

Features

- High P1dB Output Power: +31 dBm
- High Psat Output Power: +33 dBm
- High Gain: 12 dB
- High Output IP3: +41 dBm
- Supply Voltage: Vdd = +10V to +15V @ 500 mA
- 50 Ohm Matched Input/Output
- Die Size: 2.99 x 1.84 x 0.1 mm

Functional Diagram

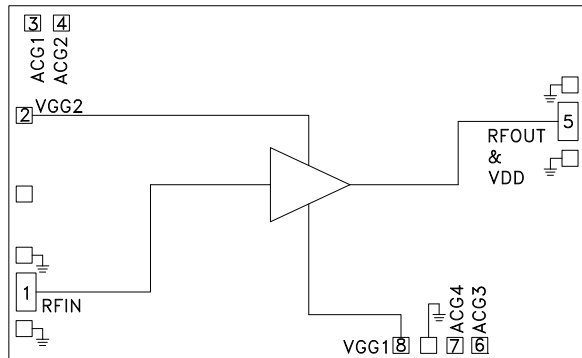

General Description

The HMC998 is a GaAs MMIC PHEMT Distributed Power Amplifier die which operates between DC and 22 GHz. The amplifier provides 12 dB of gain, +41 dBm output IP3 and +31 dBm of output power at 1 dB gain compression while requiring 500 mA from a +15V supply. This versatile PA exhibits a positive gain slope from 1 to 18 GHz making it ideal for EW, ECM, Radar and test equipment applications. The HMC998 amplifier I/Os are internally matched to 50 Ohms facilitating integration into multi-chip-modules (MCMs). All data is taken with the chip connected via two 0.025mm (1 mil) wire bonds of minimal length 0.31 mm (12 mils).

Electrical Specifications, $T_A = +25^\circ C$, $V_{dd} = +15V$, $V_{gg2} = +9.5V$, $I_{dd} = 500 mA^*$

Parameter	Min.	Typ.	Max.	Min.	Typ.	Max.	Min.	Typ.	Max.	Units
Frequency Range		0.1 - 2		2 - 18			18 - 22			GHz
Gain	9.5	11.5		10.5	12.5		10.5	12.5		dB
Gain Flatness		±0.1			±0.7			±0.6		dB
Gain Variation Over Temperature		0.006			0.11			0.016		dB/°C
Input Return Loss		-20			-20			-15		dB
Output Return Loss		-7			-20			-20		dB
Output Power for 1 dB Compression (P1dB)	29	31		29	31.5		27	30		dBm
Saturated Output Power (Psat)		33			33.5			33		dBm
Output Third Order Intercept (IP3)		41			41			40		dBm
Noise Figure		10			4			5		dB
Supply Current (Idd) (Vdd= 15V, Vgg1= -0.7V Typ.)		500			500			500		mA

* Adjust Vgg1 between -2 to 0V to achieve Idd = 500mA typical.



**GaAs pHEMT MMIC
2 WATT POWER AMPLIFIER, 0.1 - 22 GHz**

Gain & Return Loss

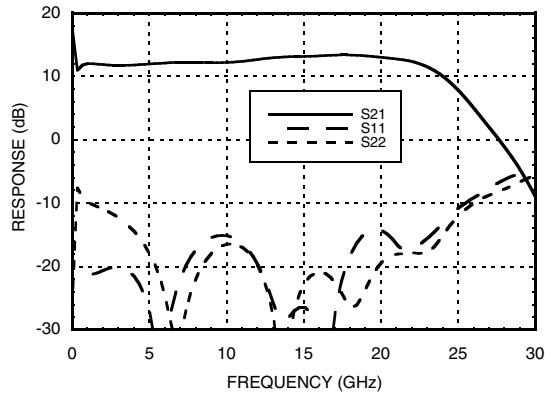

Gain vs. Temperature

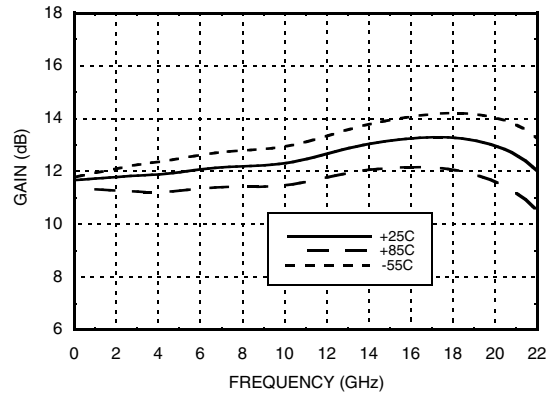

Input Return Loss vs. Temperature

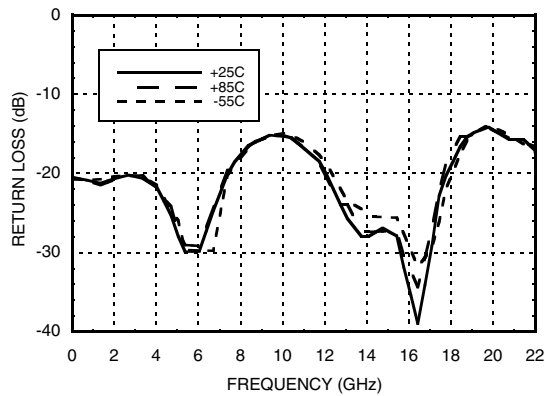

Output Return Loss vs. Temperature

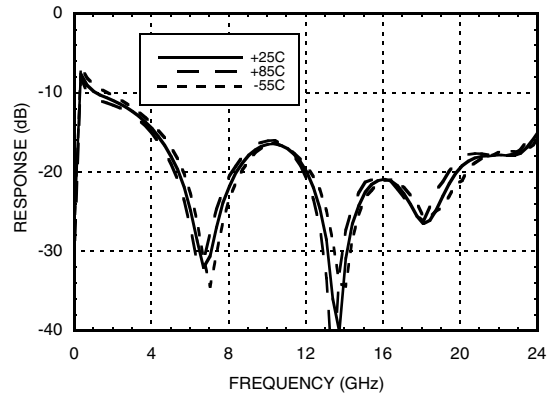

Low Frequency Gain & Return Loss

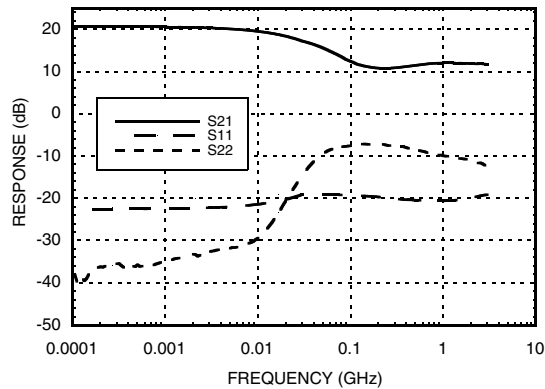

Noise Figure vs. Frequency

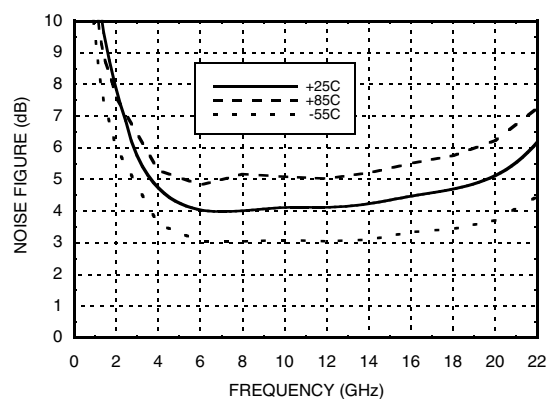

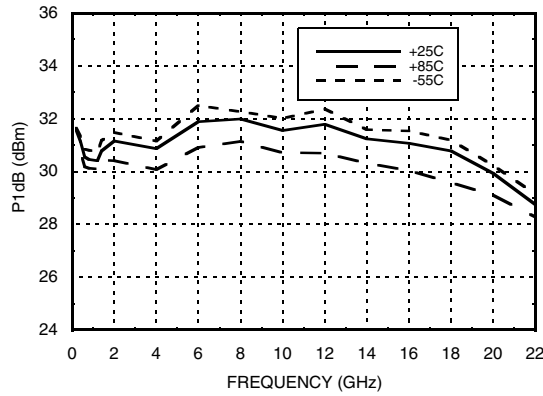
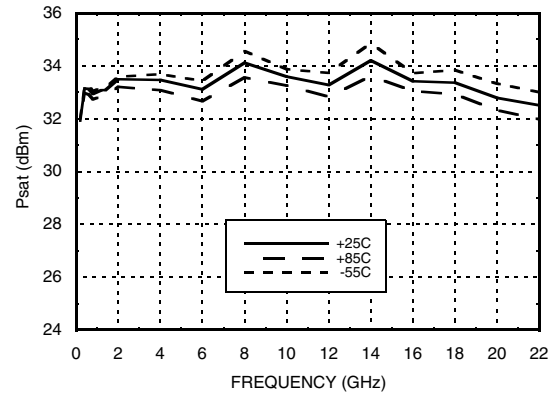
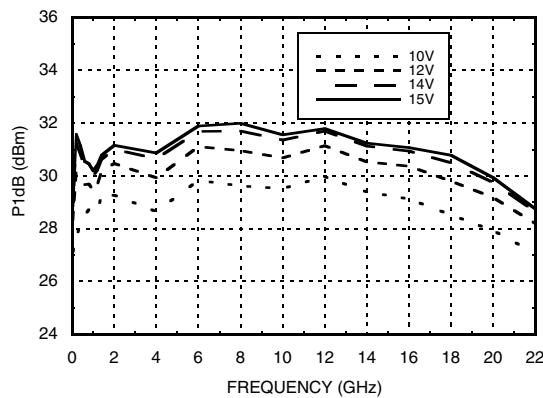
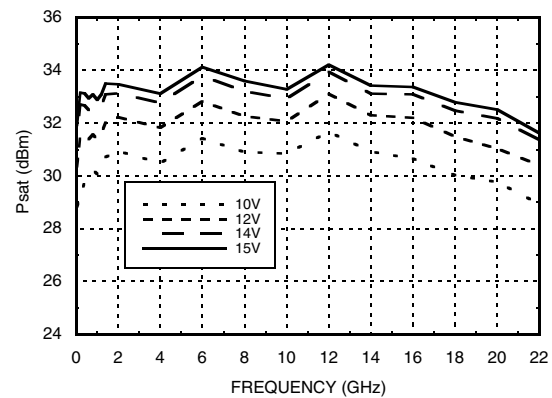
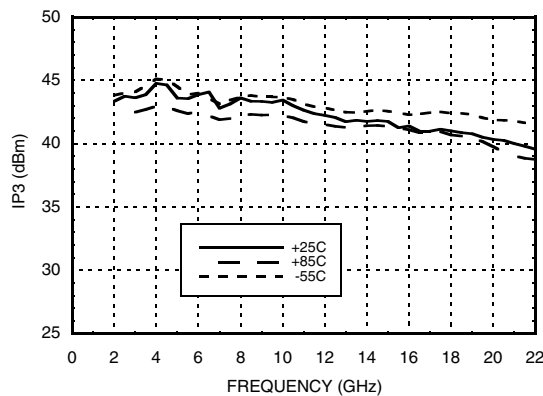
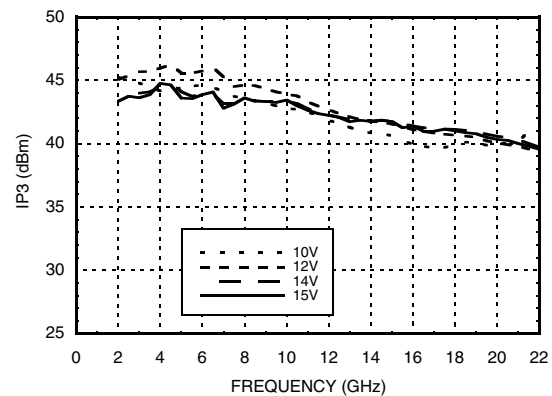
**GaAs pHEMT MMIC
2 WATT POWER AMPLIFIER, 0.1 - 22 GHz**
P1dB vs. Temperature

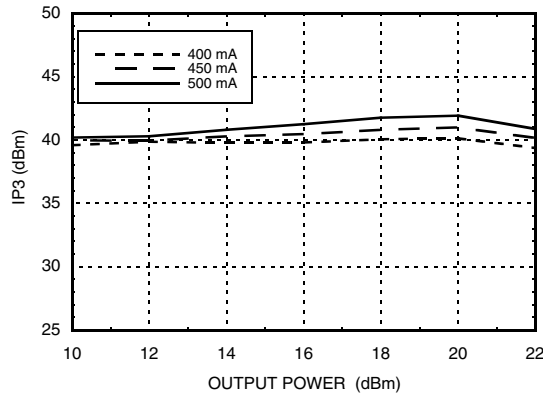
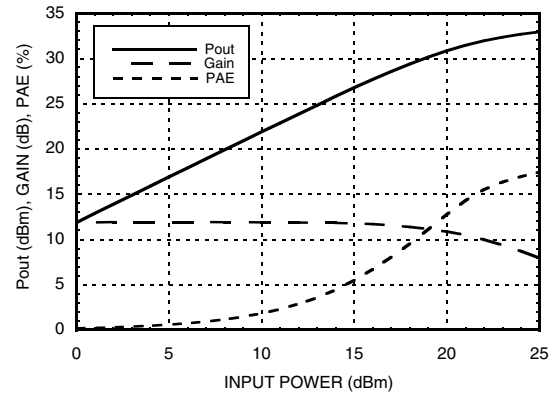
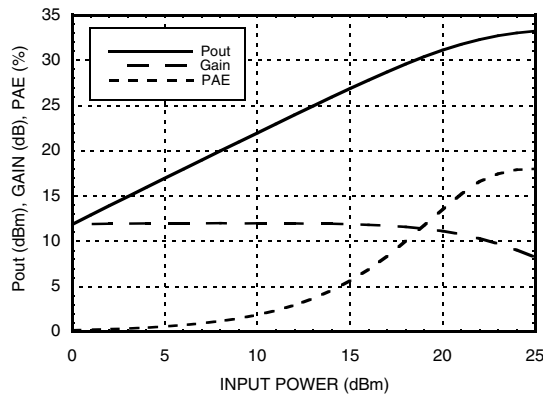
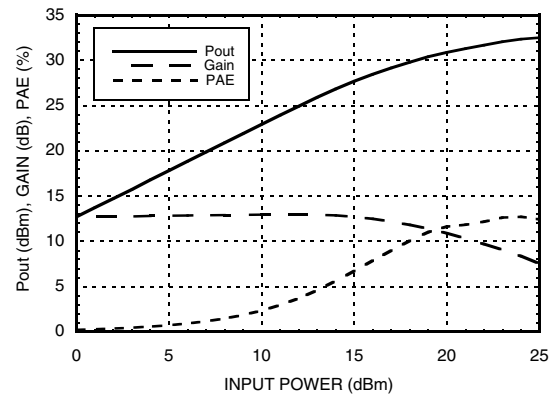
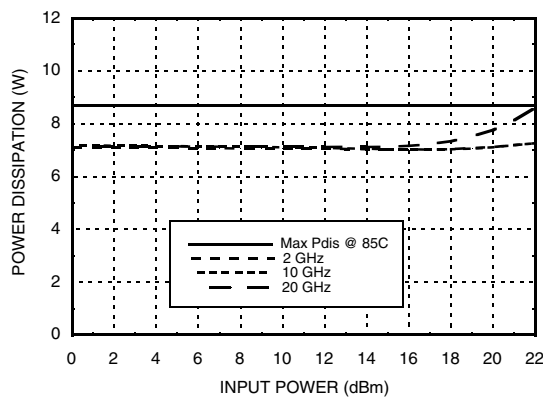
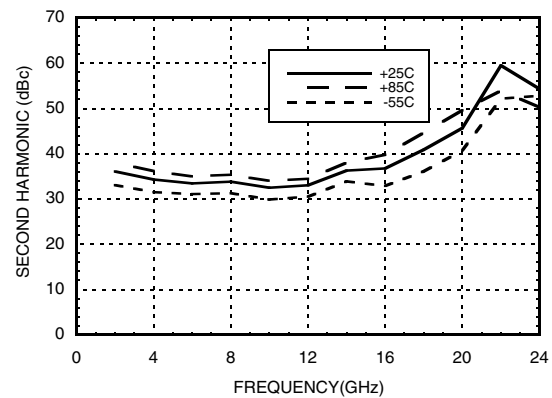
Psat vs. Temperature

P1dB vs. Vdd

Psat vs. Vdd

**Output IP3 vs. Temperature
@ Pout = 18 dBm Tone**

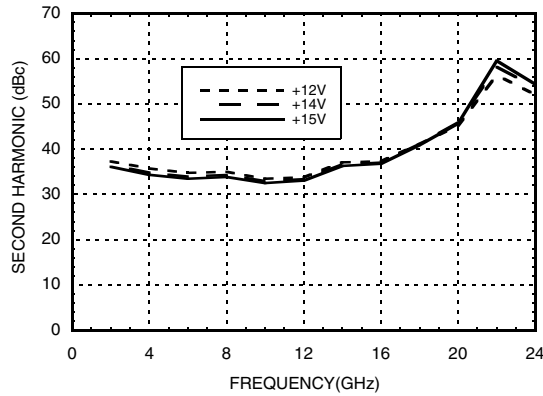
**Output IP3 vs. Vdd
@ Pout = 18 dBm Tone**



**GaAs pHEMT MMIC
2 WATT POWER AMPLIFIER, 0.1 - 22 GHz**
Output IP3 vs. Output Power @ 11 GHz

Power Compression @ 4 GHz

Power Compression @ 10 GHz

Power Compression @ 20 GHz

Power Dissipation

**Second Harmonics vs.
Temperature @ Pout = 18 dBm**



**GaAs pHEMT MMIC
2 WATT POWER AMPLIFIER, 0.1 - 22 GHz**

**Second Harmonics vs.
Vdd @ Pout = 18 dBm**



Second Harmonics vs. Pout

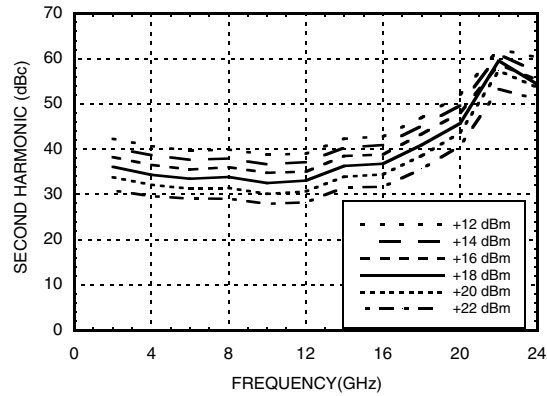

Reverse Isolation vs Temperature

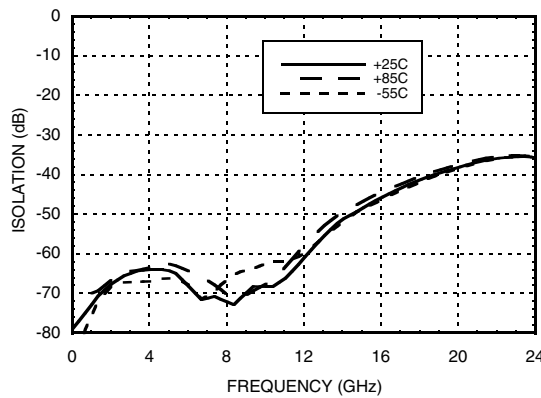

Absolute Maximum Ratings

Drain Bias Voltage (Vdd)	+17 Vdc
Gate Bias Voltage (Vgg1)	-3 to 0 Vdc
Gate Bias Voltage (Vgg2)	Vgg2 = (Vdd - 6.5V) to (Vdd-4.5V)
RF Input Power (RFIN)	+27 dBm
Channel Temperature	150 °C
Continuous Pdiss (T= 85 °C) (derate 129 mW/°C above 85 °C)	8.4 W
Thermal Resistance (channel to die bottom)	7.73 °C/W
Output Power into VSWR >7:1	+32 dBm
Storage Temperature	-65 to 150°C
Operating Temperature	-55 to 85 °C

Typical Supply Current vs. Vdd

Vdd (V)	Idd (mA)
+12	500
+14	500
+15	500

Vgg1 adjust to achieve Idd = 500 mA



**ELECTROSTATIC SENSITIVE DEVICE
OBSERVE HANDLING PRECAUTIONS**



GaAs pHEMT MMIC 2 WATT POWER AMPLIFIER, 0.1 - 22 GHz

Outline Drawing

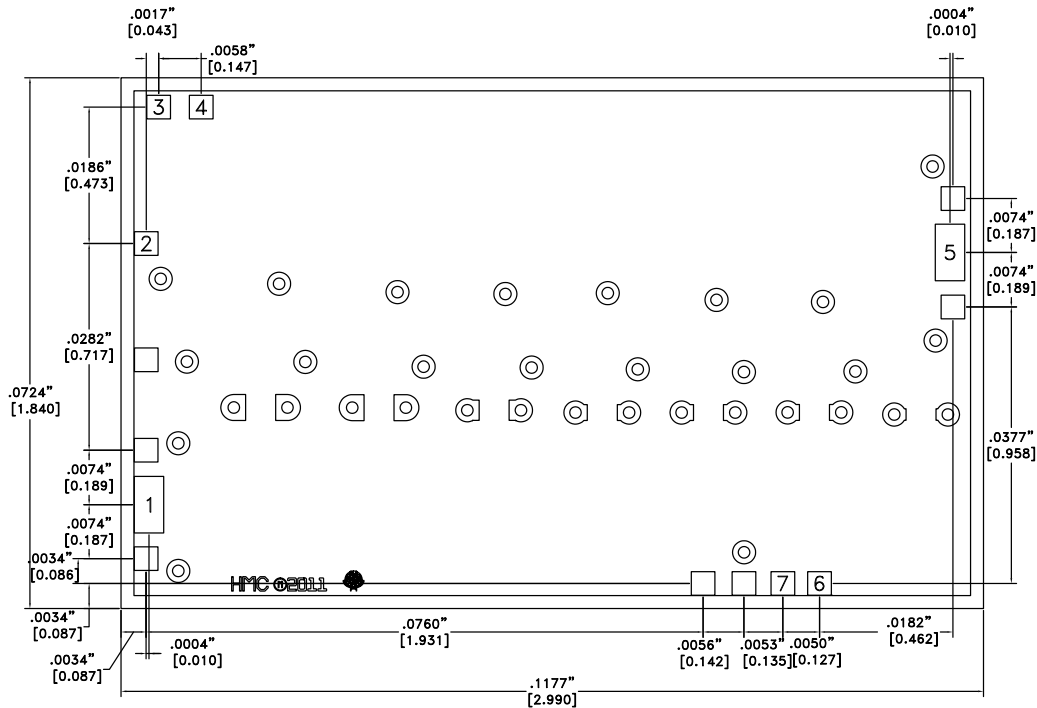

Die Packaging Information ^[1]

Standard	Alternate
GP-1 (Gel Pack)	[2]

[1] For more information refer to the "Packaging Information" Document in the Product Support Section of our website .

[2] For alternate packaging information contact Hittite Microwave Corporation.

NOTES:

1. ALL DIMENSIONS ARE IN INCHES [MM]
2. DIE THICKNESS IS 0.004"
3. TYPICAL BOND PAD IS 0.004" SQUARE
4. BOND PAD METALIZATION: GOLD
5. BACKSIDE METALIZATION: GOLD
6. BACKSIDE METAL IS GROUND
7. NO CONNECTION REQUIRED FOR UNLABELED BOND PADS
8. OVERALL DIE SIZE ±0.002"



**GaAs pHEMT MMIC
2 WATT POWER AMPLIFIER, 0.1 - 22 GHz**

Pad Descriptions

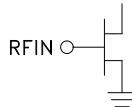
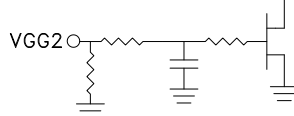
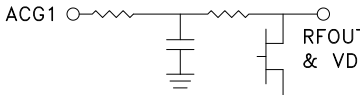
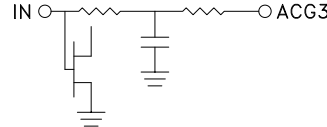
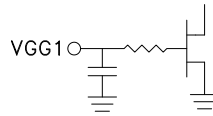
Pad Number	Function	Description	Interface Schematic
1	RFIN	This pad is DC coupled and matched to 50 Ohms. Blocking capacitor is required.	
2	VGG2	Gate control 2 for amplifier. Attach bypass capacitor per application circuit herein. For nominal operation +9.5V should be applied to Vgg2.	
4, 7	ACG2, ACG4	Low frequency termination. Attach bypass capacitor per application circuit herein.	
3	ACG1	Low frequency termination. Attach bypass capacitor per application circuit herein.	
5	RFOUT & VDD	RF output for amplifier. Connect DC bias (Vdd) network to provide drain current (Idd). See application circuit herein.	
6	ACG3	Low frequency termination. Attach bypass capacitor per application circuit herein.	
8	VGG1	Gate control 1 for amplifier. Attach bypass capacitor per application circuit herein. Please follow "MMIC Amplifier Biasing Procedure" application note.	
Die Bottom	GND	Die bottom must be connected to RF/DC ground.	



**GaAs pHEMT MMIC
2 WATT POWER AMPLIFIER, 0.1 - 22 GHz**

Assembly Diagram

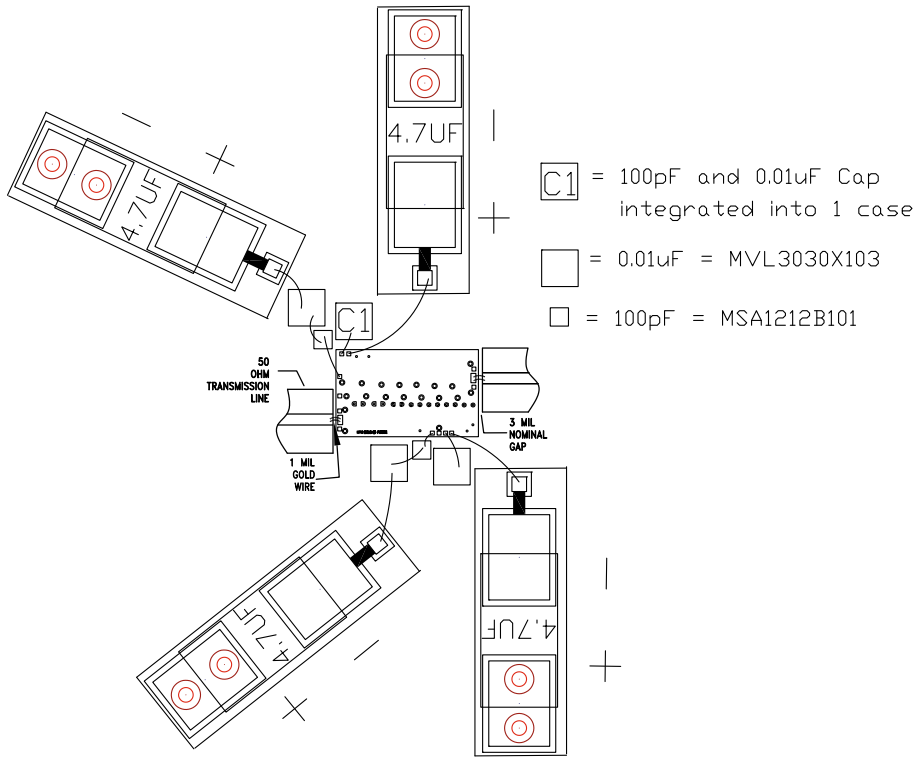

Application Circuit

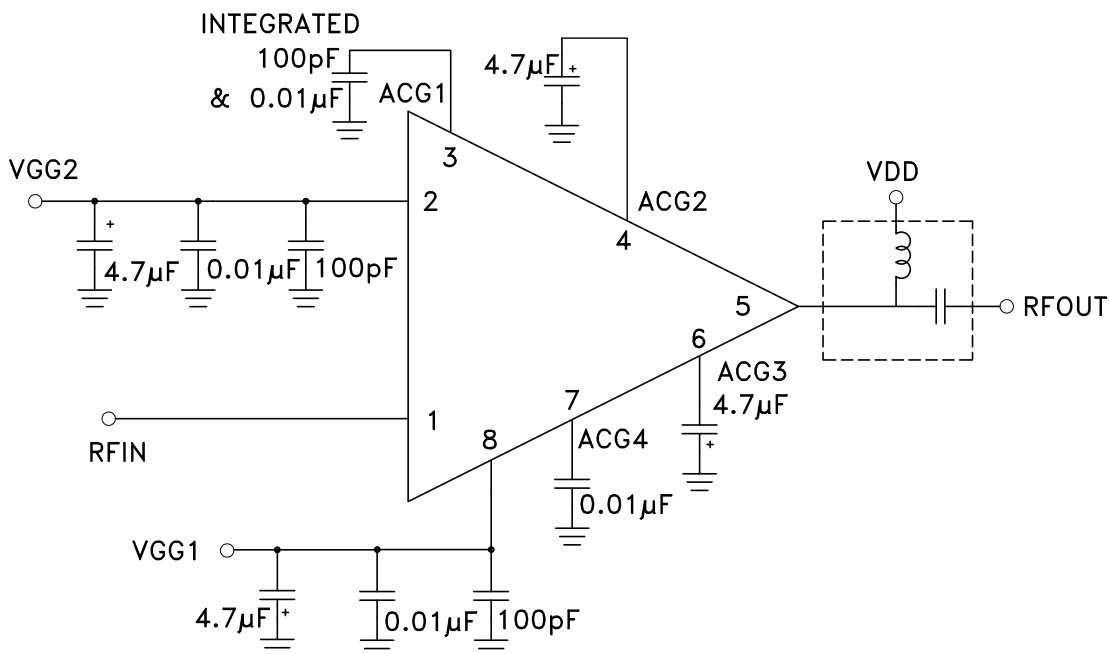

NOTE 1: Drain Bias (Vdd) must be applied through a broadband bias tee with low series resistance and capable of providing 800mA



GaAs pHEMT MMIC 2 WATT POWER AMPLIFIER, 0.1 - 22 GHz

Mounting & Bonding Techniques for Millimeterwave GaAs MMICs

The die should be attached directly to the ground plane eutectically or with conductive epoxy (see HMC general Handling, Mounting, Bonding Note).

50 Ohm Microstrip transmission lines on 0.127mm (5 mil) thick alumina thin film substrates are recommended for bringing RF to and from the chip (Figure 1). If 0.254mm (10 mil) thick alumina thin film substrates must be used, the die should be raised 0.150mm (6 mils) so that the surface of the die is coplanar with the surface of the substrate. One way to accomplish this is to attach the 0.102mm (4 mil) thick die to a 0.150mm (6 mil) thick molybdenum heat spreader (moly-tab) which is then attached to the ground plane (Figure 2).

Microstrip substrates should be located as close to the die as possible in order to minimize bond wire length. Typical die-to-substrate spacing is 0.076mm to 0.152 mm (3 to 6 mils).

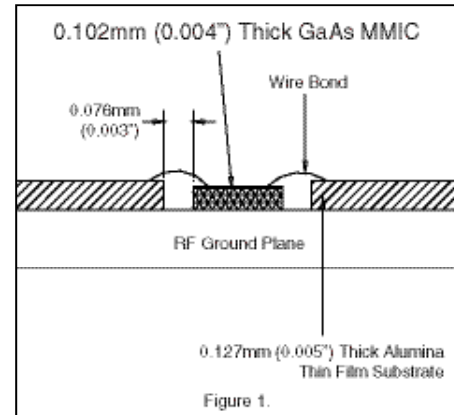

Handling Precautions

Follow these precautions to avoid permanent damage.

Storage: All bare die are placed in either Waffle or Gel based ESD protective containers, and then sealed in an ESD protective bag for shipment. Once the sealed ESD protective bag has been opened, all die should be stored in a dry nitrogen environment.

Cleanliness: Handle the chips in a clean environment. DO NOT attempt to clean the chip using liquid cleaning systems.

Static Sensitivity: Follow ESD precautions to protect against > ± 250V ESD strikes.

Transients: Suppress instrument and bias supply transients while bias is applied. Use shielded signal and bias cables to minimize inductive pick-up.

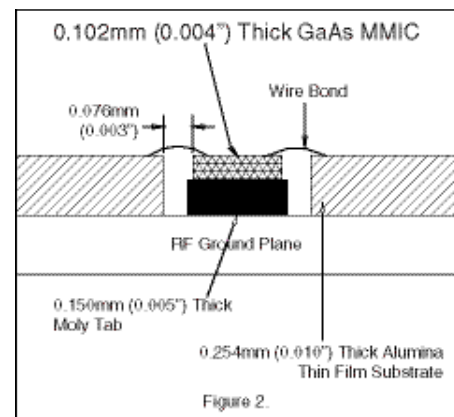

General Handling: Handle the chip along the edges with a vacuum collet or with a sharp pair of bent tweezers. The surface of the chip may have fragile air bridges and should not be touched with vacuum collet, tweezers, or fingers.

Mounting

The chip is back-metallized and can be die mounted with AuSn eutectic preforms or with electrically conductive epoxy. The mounting surface should be clean and flat.

Eutectic Die Attach: A 80/20 gold tin preform is recommended with a work surface temperature of 255 °C and a tool temperature of 265 °C. When hot 90/10 nitrogen/hydrogen gas is applied, tool tip temperature should be 290 °C. DO NOT expose the chip to a temperature greater than 320 °C for more than 20 seconds. No more than 3 seconds of scrubbing should be required for attachment.

Epoxy Die Attach: Apply a minimum amount of epoxy to the mounting surface so that a thin epoxy fillet is observed around the perimeter of the chip once it is placed into position. Cure epoxy per the manufacturer's schedule.

Wire Bonding

Ball or wedge bond with 0.025mm (1 mil) diameter pure gold wire. Thermosonic wirebonding with a nominal stage temperature of 150 °C and a ball bonding force of 40 to 50 grams or wedge bonding force of 18 to 22 grams is recommended. Use the minimum level of ultrasonic energy to achieve reliable wirebonds. Wirebonds should be started on the chip and terminated on the package or substrate. All bonds should be as short as possible <0.31mm (12 mils).



**GaAs pHEMT MMIC
2 WATT POWER AMPLIFIER, 0.1 - 22 GHz**

Notes: